

EB-Therm 800

Multifunctional digital thermostat with four operation modes for DIN installation

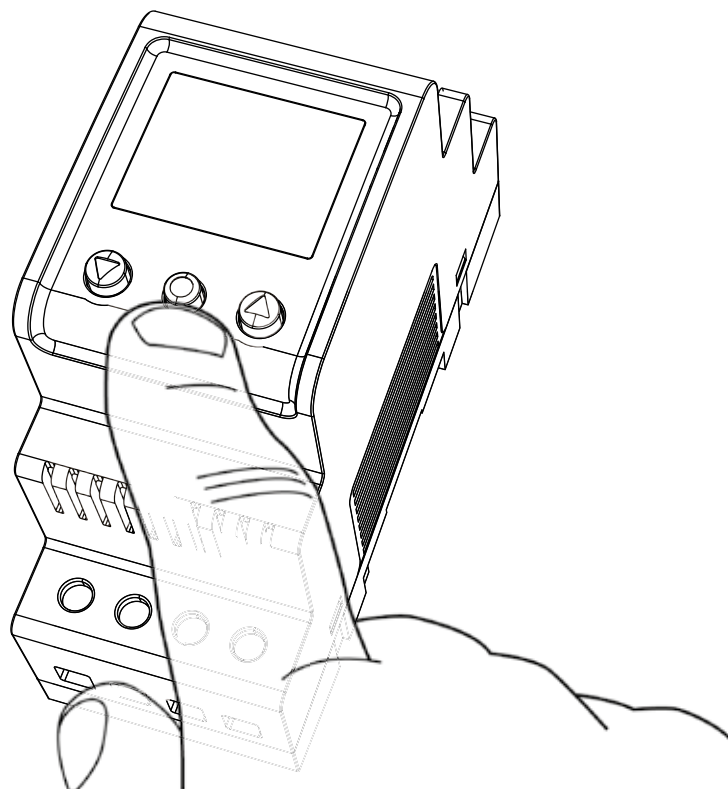

EB-Therm 800

Thank you for choosing Ebeco and EB-Therm 800, which we hope will serve you well for a long time to come.

This is a microprocessor controlled thermostat intended for DIN installation with a background lit LCD display. There are three operation buttons on the front. There are four operation modes and several temperature reduction programs to choose between for energy smart control. Furthermore, it is possible to adapt the programming to fully suit your own temperature needs.

It is important to read the manual carefully since, for the guarantee to be valid, the product must be installed and used in accordance with it. This applies to both the installation electrician and the user of the thermostat.

The manual also contains information on fault tracing as well as technical data. If you have any questions, please contact us at Ebeco.

Call +46 31-707 75 50 or send an e-mail to info@ebeco.se.

For more information, visit ebeco.com.



This is a high current unit and must therefore be installed according to applicable regulations and be approved by an authorised electrician.

Contents

Included in the package

Accessories	4
--------------------------	----------

Installation	5
---------------------------	----------

Thermostat	5
------------------	---

Sensor	5
--------------	---

Introduction	6
---------------------------	----------

Four operation modes	6
----------------------------	---

Menu navigation	7
-----------------------	---

Start menu	8
------------------	---

Display mode	9
--------------------	---

Functions in display mode	9
---------------------------------	---

Operation mode	11
-----------------------------	-----------

Main menu	11
-----------------	----

Temperature menu	11
------------------------	----

Program menu	12
--------------------	----

System setting menu	15
---------------------------	----



Operation mode Cooling	18
-------------------------------------	-----------

Main menu	18
-----------------	----

Temperature menu	18
------------------------	----

Program menu	18
--------------------	----

System setting menu	21
---------------------------	----



Operation mode Industry	24
--------------------------------------	-----------

Main menu	24
-----------------	----

Temperature menu	24
------------------------	----

Program menu	26
--------------------	----

System setting menu	27
---------------------------	----



Operation mode Max/Min	29
-------------------------------------	-----------

Main menu	29
-----------------	----

Temperature menu	29
------------------------	----

Program menu	30
--------------------	----

System setting menu	31
---------------------------	----



Fault tracing	34
----------------------------	-----------

Technical data	35
-----------------------------	-----------

Included in the package

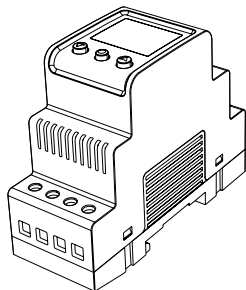

1. Thermostat E 85 816 10

2. Quick guide

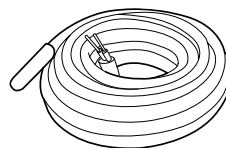

3. Sensor cable 3 m E 85 816 71



Accessories

Depending on how you are going to use your thermostat, you may need to complement it with some of the parts below.

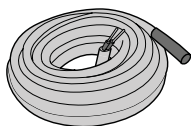

1.

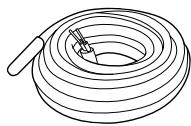

2.

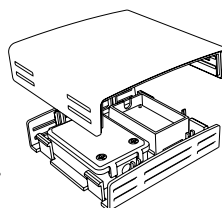

3.

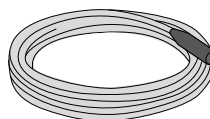

4.

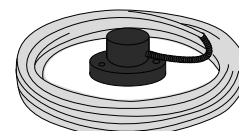

5.

1. Sensor cable 3 m (High temperature sensor) E 85 816 73

You need to use this part if you are going to control temperatures above +75 -150 °C.

2. Sensor cable 6 m (Low temperature sensor) E 85 816 84

3. Encapsulated sensor IP20/ IP54 E 85 816 22

You need to complement with this part if you are using the thermostat as a room thermostat or in connection with the max/min program for roof installations. It must be permanently in the shade, e.g. on the north side or a shade side. Ensure that it is not affected by heat emittance from the building or a heating cable.

4. Roof sensor, E 89 350 75

You need to complement with this moisture sensor if you are using the moisture function in the max/min program for roof installations.

5. Ground sensor, E 85 801 01

You need to complement with this sensor if you are using the moisture & temperature function in the max/min program for ground installations.

Installation

Thermostat

EB Therm 800 must be installed on a DIN standard rail (EN 50022-35) in a normskåp with the applicable encapsulation class. EB Therm 800 is IP20 classed and intended for installation in environments with a temperature range of -20 °C to +45 °C.

The thermostat has 14 terminal blocks numbered according to the wiring diagram below:

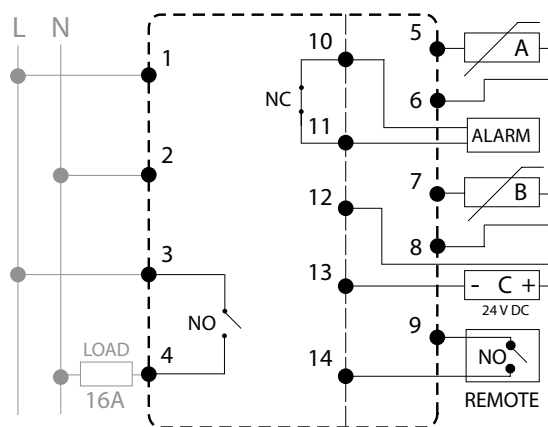

The incoming phase and neutral are connected to terminals 1 and 2.

Terminals 3 and 4 are the relay that regulates the load.

Sensor A is connected to 5 and 6.

Sensor B is connected to 7 and 8.

A possible external alarm (max. 2A, 120VAC) is connected to terminals 10 and 11.

Sensor C (moisture) is connected to 12 and 13.

A possible remote control unit is connected to 9 and 14.

Sensor

If the EB Therm 800 is going to be used as a floor heating thermostat, connect the room sensor as A, and the floor sensor as B. If you are installing a floor that requires over heating protection, connect the room sensor as A and the over heating protection as B.

Install the floor sensor in a spiral tube (E89 605 41) recessed in the floor. The end of the tube must be sealed to facilitate possible replacement of the sensor.

Place the room sensor so that it is not exposed to direct sunlight or draught. If the room sensor is installed in an appliance box, it must be sealed to prevent the air temperature being affected by draught.

For other types of operation and control, the temperature sensor can be installed as either A, B or A+B. For operation type max/min, the moisture sensor (E89 350 8935075) can also be installed as sensor C. You give the location of the sensor in the START MENU. The high temperature sensor (E85 816 73) is recommended for temperatures above +75-150 °C. Only one high temperature sensor can be connected. It must always be connected as B, terminal block 7 and 8.

Introduction

The manual, like the thermostat, is divided into four operation modes so that you only need to read about the functions you will use. The thermostat operation mode can only be installed in the start menu, which is shown the first time the thermostat is started (read more about the start menu on page 8) or after it has been reset.

Four operation modes

HEATING

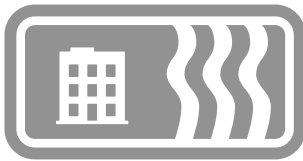

Operation mode **HEATING** is used in homes, offices, storerooms and such like. With this operation mode, you can regulate the heating within a temperature range of +5 °C to +45 °C. The thermostat can be used as a floor thermostat, room thermostat or room thermostat with over heating protection for wood floors. The energy saving program is primarily adapted for home and office environments, but can also be used for regulating heating levels in, for example, storerooms.

COOLING



Operation mode **COOLING** is used in homes, offices, storerooms and such like. In this operation mode, the thermostat works as a room thermostat for regulating air conditioning or other cooling within a temperature range of +5 °C to +45 °C. Energy saving programs are primarily adapted for home and office environments but can also be used for cooling, for example, storerooms.

INDUSTRY

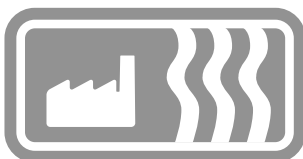

Operation mode **INDUSTRY** is used to regulate the temperature of industrial processes, high temperatures or for the frost protection of sensitive installations. Temperatures within the ranges -15 °C to +75 °C and 0 °C to +150 °C can be regulated in this mode or the range can be limited to between -10 °C and +15 °C for frost protection purposes. It is also possible to adjust temperature hysteresis and set upper and lower temperature alarms.

MAX/MIN



The Max/Min operating position is mainly used to keep roof and ground surfaces free of snow and ice. The temperature range is adjustable between -20 °C and +10 °C. For the best results and the best energy saving, combined temperature and humidity control should be used in the Max-/Min position, with associated Roof Sensor (E 89 350 75) or Ground Sensor (E 85 801 01).



Menu navigation

The functions in EB Therm 800 are arranged in a system of menus and sub-menus. The Main menu always contains three submenus **TEMP**, **PROGRAM** and **SYSTEM**. There are further choices under these.

The first time the thermostat is started, a number of requisite values must be set in the **START** menu (see page 8). The **START** menu is then not shown again: the thermostat always opens in display mode (see page 9).

The thermostat has two modes for background lighting, full and half strength. If no buttons are pressed for 30 seconds, the background lighting reverts to half strength. By pressing one of the three buttons, you can change to full strength; the thermostat remains in display mode.

The menus are reached by pressing  a second time in display mode.

The top row is always the name of the menu you are in. Use  or  to move the round marker; the marked line you are on blinks. Press  to select the marked alternative. At the bottom of each menu there is an **EXIT**, which returns you to the previous menu.

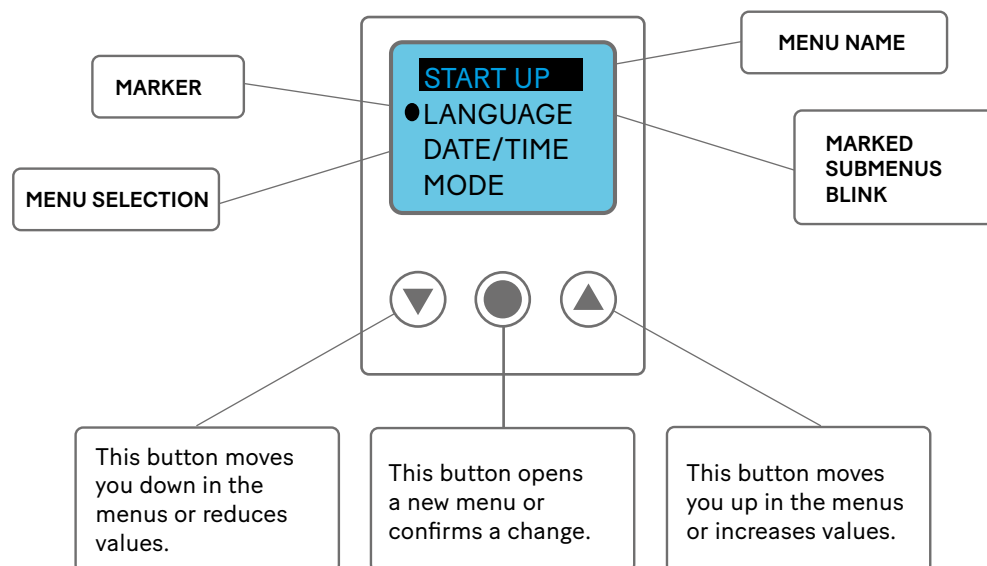

To reset the thermostat to factory settings, use the **RESET** function, which you can read more about on page 16.



Start menu



The start menu is used to quickly and simply set the three requisite basic settings; it is only shown the first time the thermostat is switched on (or if the thermostat is fully reset using the reset function). Begin by choosing a language, continue with the date and time setting, and finish off by setting operation mode and sensor. The headings in grey are the menu name used in the thermostat.

1 Language setting LANGUAGE

You can choose between several languages; the factory setting is English. Set the required language by scrolling through them using the  or  button and confirm with .

2 Date & time DATE/TIME



The time and date must be set in order for the program functions to work correctly. The thermostat automatically sets the day of the week and summer and winter time (this function can later be switched off later if so desired).

The value that is blinking can be decreased or increased using the  or  button; when the required setting is made, confirm it with  and the next value will start to blink. Repeat this procedure until all the values are set. Start by setting the applicable date, month and year. Then set hours and minutes.

3 Operation mode OPERATION MODE

There are four operation modes: **HEATING**, **COOLING**, **INDUSTRY** or **MAX/MIN**. The operation mode can only be selected in the start menu and cannot be changed after this menu is left.

The settings for heating and cooling are for regulating the temperature in home, office and storeroom environments or similar. The industry mode is used for controlling industrial processes and high temperatures or to safeguard sensitive installations against frost damage. Max/Min is used above all to keep roof and ground surfaces free of snow and ice.

Set the required operation mode by scrolling through them using the  or  button and confirm with . When you have selected the mode that best suits your needs, configure the sensors for your installation. Read more about sensor settings under the section for the operation mode you have selected.

4 Exit the start menu EXIT

When you have made all the settings, press **EXIT** to leave the start menu; by pressing **YES** you come directly to **DISPLAY MODE**, which is the "normal" mode for the thermostat.

Display mode

The display mode is the thermostat's "normal" mode; the most important settings, statuses and functions are shown and set here. The display shows, alternately, the set point and current values at the same time as it always shows the operation mode and if the installation is switched on or off. The set point is the desired value, whereas the current value is the temperature or moisture status at this point in time.

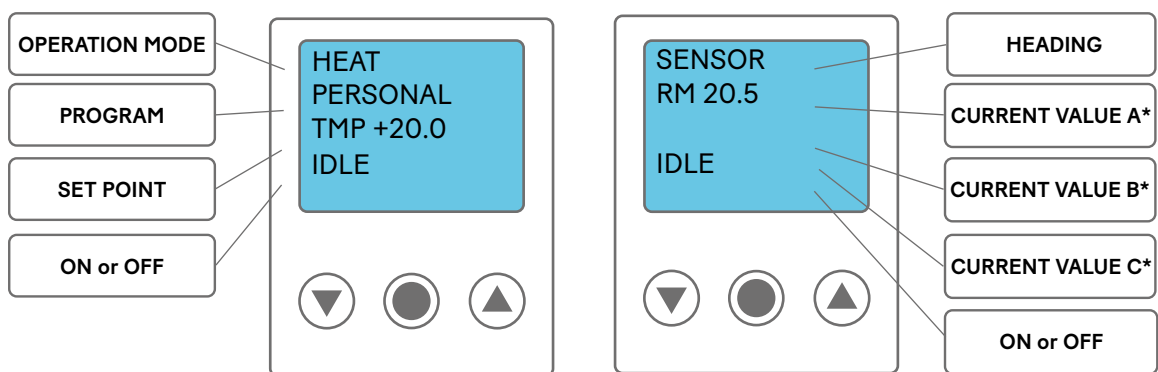

* *CURRENT VALUE A* shows the temperature at sensor A and *CURRENT VALUE B* shows the temperature at sensor B. *CURRENT VALUE C* shows whether moisture is detected by sensor C. The current value is only shown for the sensors that are installed and activated.

Functions in the display mode

The display mode contains six functions: **OVERVIEW**, **MAIN MENU**, **CONNECTION TIME**, shortcut to **TEMP** menu and set point, shortcut to **LANGUAGE** menu and **STANDBY MODE**.

30 seconds after the last button press, the thermostat always returns to display mode, irrespective of where in the menus you are. If you are ever unsure of whether you are in the required menu or setting, you can always let the thermostat return to display mode; no settings are then saved (if you have not pressed to confirm), and you can start again from the beginning.

Overview [press ▼ 3 s]

To quickly and easily gain an overview of the thermostat settings, press ▲ for three seconds to activate the overview function. You can then use ▼ and ▲ to browse through the thermostat settings. To return to display mode, press ● or wait thirty seconds.

Main menu [press ●]

When the thermostat is in display mode, press ● to go to the main menu. From the main menu, you can reach all settings (read more about the main menu under the section for the selected operation mode). To return to the display mode, wait thirty seconds or EXIT.

Connection time [press ▲]

To see the total and momentary connection times*, press ▲ when the thermostat is in display mode. The counter shows the total hours the thermostat has been connected for as well as the momentary time, in the same way as a vehicle trip meter, i.e. the number of hours the installation has been connected for since the counter was reset. The connection time is used to calculate the energy consumption** of the installation.

The momentary counter is reset in the **SYSTEM MENU** under **RESET** and **COUNTER**; both counters are reset if the thermostat is reset to factory settings. To return to display mode, press ● or wait thirty seconds.

**Connection time = the time that the thermostat has been activated, i.e. how long the heating or cooling installation has been connected for.*

***Energy consumption (kWh) = Installed effect (kW) x Connection time (h)*

Shortcut to language setting [press ▲ 3 s]

To change the language setting without going through the menu system, press ▼ when the thermostat is in display mode. Then you come directly to the language menu (read more about the language menu under the section concerning the selected operation mode).

Shortcut to temperature setting [press ▼ 3 s]

To quickly change the temperature setting without going through the main menu, go to display mode and press ▼ for three seconds; this takes you directly to temperature setting (set point).

Standby mode [press ● 3 s]

When the thermostat is in standby mode, the temperature is not regulated and the screen is inactive, but the clock runs as usual and all the settings are stored in the memory. *Note that the thermostat is still supplied with electricity.*

Standby mode is set from the display mode by pressing ● for three seconds; you are then asked if you want to switch off the thermostat. If you select **YES** standby mode is activated; if you select **NO** (or wait thirty seconds) the thermostat returns to display mode. To exit standby mode, press any button. This will return you to display mode.

Now we have gone through everything that is required to go directly to the operation mode you will use in the thermostat. There, you can read more about all the functions and how to set them to get the most out of your thermostat.



Operation mode Heating

Heating mode is used in homes, offices, storerooms and such like. With this operation mode, you can regulate the heating within a temperature range of +5 °C to +45 °C. The thermostat can be used as a floor thermostat, room thermostat or room thermostat with over heating protection for wood floors. The energy saving program is primarily adapted for home and office environments, but can also be used for regulating heating levels in, for example, storerooms.

Main menu MAIN MENU

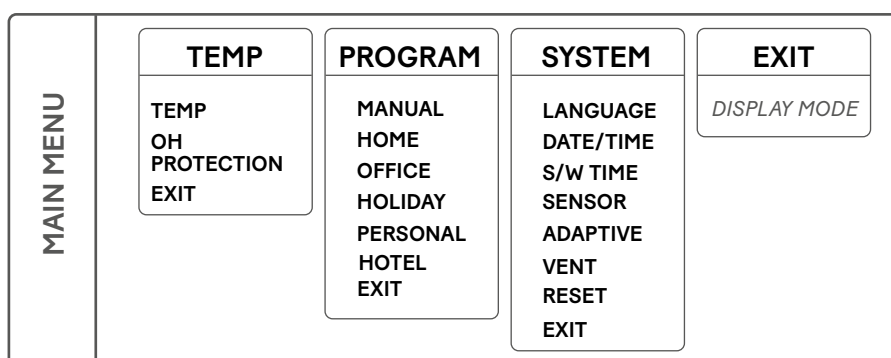

MAIN MENU contains three submenus: TEMP, PROGRAM, SYSTEM and EXIT, which returns you to display mode.



Temperature menu TEMP

The temperature menu contains the functions that in some way concern direct temperature regulation. This is where the set point and, if applicable, over heating protection are set. The temperature menu is reached via TEMP in the MAIN MENU.

Set point TEMP

The set point setting is under TEMP in the temperature menu. Set the required temperature by pressing  or  and confirm by pressing . The set point can be set to an accuracy of 0.5 degrees within the range +5 °C to +45 °C; it is preset to +22 °C.

Over heating protection OH PROTECTION

Over heating protection works as a floor temperature limiter; if you have a wood or laminate floor, you must always use a room sensor with over heating protection to ensure that the floor material is safeguarded against over heating and damage.

Over heating protection is under OH PROTECTION under TEMP. The limitation can be set between +5 °C and +45 °C. The factory setting is +35 °C, which gives a surface temperature of about +27 °C.





The surface temperature is an average value and varies somewhat depending on the material and the thickness. Denser (harder) wood insulates less than softer wood, which increases the surface temperature. Also, the thinner the floor, the higher the surface temperature.

Two sensors are required for over heating protection: a room sensor (sensor A) and an over heating protection sensor (sensor B).

Program menu PROGRAM

A smart way of saving energy is to adapt the heating to suit the needs throughout the day and, for example, lower the temperature when there is nobody home. There are four different ways of lowering the temperature: two preset programs for home or office environments, one program for personal settings and a frost protection program. There is no need to consider the heating time when programming since the thermostat has an adaptive function that applies this automatically.

The programs are in the **MAIN MENU** under **PROGRAM**. To change program, browse using  or  and select using . The manual program is the factory setting, i.e. you set the required temperature (set point) and the thermostat maintains that temperature.

Program for home environment HOME

The temperature is lowered automatically by 5 °C at the following times:
Monday–Friday 08:30–15:00 and every day between 23:00–05:00.

The home environment program is under **PROGRAM** in the **MAIN MENU**. Select **HOME** using  and a message is shown for two seconds to confirm that the program has been activated. You can then see in display mode that the program is active when **HOME** is shown on the second row.

The temperature can be set between +5 °C and +45 °C. The thermostat works from the temperature that is set in the manual program where the factory setting is +22 °C. If you change the temperature in the manual program, or the set point in the **TEMP** menu, the thermostat works from the new temperature, and lowers the temperature by +5 °C from the newly set temperature.

Program for office environment OFFICE

The temperature is lowered automatically by 5 °C apart from at the following times:
Monday–Friday 06:00–18:00.

The office environment program is under **PROGRAM** in the **MAIN MENU**. Select **OFFICE** using  and a message is shown for two seconds to confirm that the program has been activated. You can then see in display mode that the program is active when **OFFICE** is shown on the second row.



The temperature can be set between +5 °C and +45 °C. The thermostat works from the temperature that is set in the manual program where the factory setting is +22 °C. If you change the temperature in the manual program, or the set point in the **TEMP** menu, the thermostat works from the new temperature, and lowers the temperature by +5 °C from the newly set temperature.

Holiday program HOLIDAY

This program is intended for saving energy and safeguarding against frost damage in premises that are empty or unused for long periods, such as holiday homes and storerooms, or unusually long periods of absence from home. The holiday program can be controlled via a remote control unit. There are three menu alternatives to choose between under **HOLIDAY: ACTIVATE, CHANGE** and **RESET**.

HOLIDAY is under **PROGRAM** in the **MAIN MENU**. The temperature can be set between +5 °C and +20 °C; the factory setting is +12 °C.

ACTIVATE

The program is started with **ACTIVATE**, and from there you can choose to use **TIMER SETTING**. If you want to start the program without the timer function, select **NO** and the program will then be active until another program is started. If you select **YES**, the program will remain active for the selected time and will then return to the previously used program.

The first time the program is used, the time and temperature must be set under **CHANGE**. All the settings are saved in the memory and are not lost even if a power cut occurs, but, in this case, the clock must be reset to obtain normal functionality again.

CHANGE

To make changes to the settings, select **CHANGE**; **TEMP** is used to set the temperature you want the thermostat to maintain when the program is activated, **TIMER** is used to reset the current start and stop times; **REMOTE** is used to activate remote control if applicable.

RESET

There is also a reset function, which resets the program to the factory setting, +12 °C, and deletes all the time settings.

REMOTE CONTROL

The holiday program can be controlled via a remote control unit. The unit is connected to the applicable terminal block; see the wiring diagram. The holiday program is activated when the remote control input is closed, and is deactivated when it is opened again. The thermostat then returns to its previous setting.



Personal program [PERSONAL]

Manual setting of the program allows optimisation of energy consumption to suit just your needs by making settings for four events each day: **WAKE**, **AWAY**, **HOME** and **NIGHT**. There are three menu alternatives to choose between: **ACTIVATE**, **CHANGE** and **RESET**.

The personal program **PERSONAL** is under **PROGRAM** in the **MAIN MENU**. The temperature can be set between +5 °C and +45 °C; the factory setting is +22 °C.





ACTIVATE

The program is started with **ACTIVATE** and remains active until another program is started. All the settings are saved in the memory and are not lost even if a power cut occurs for a period longer than two days, but, in this case, the clock must be reset to obtain normal functionality again.

CHANGE

To set your personal program go in under **CHANGE**. There are different ways of setting the various events; you can choose to program day by day, weekend (Saturday and Sunday) or the whole week. It is normally easiest to set the whole week first and then adjust this for the days requiring a different setting.

When you have decided on the day(s) the event shall be set for, set the time of day they shall occur at and the required floor temperature at that time.

Start by setting the time, which is blinking. Browse with the  or the  button to the time you want the event **WAKE** to occur. First set hours, confirm with , then minutes, confirm with . Browse to the required temperature for **WAKE**. Confirm with  and **AWAY** then shows. Repeat the steps above to set the time and temperature, and **HOME** then shows. Repeat the steps above to set the time and temperature, and **NIGHT** then shows. Repeat the steps above to set the time and temperature.

RESET

There is also a reset function, which resets the program to the factory setting, +22 °C, and deletes all the time settings.

Program for hotel environments HOTEL

This program allows you to control the heating via external card readers with a delay time, since the thermostat has an integrated time relay function. The temperature settings change automatically when the hotel guest comes into or leaves the room and the delay time is fully adjustable, making it easy to decide how long the heating is to keep running after the guest has left the room.

The Hotel program can be found under **PROGRAMS** in the **MAIN MENU**. You select **HOTEL** with . This displays the different settings that you can make in the program. There are three settings to choose from: **+HEAT**, **LOW TEMP** and **ACTIVATE**.



+HEAT

Time relay, Off-delay: adjustable from 0 to 4 hours. The factory setting is 2 hours.

LOW TEMP

Set point can be set to between +5 °C and +20 °C. The factory setting is +15 °C.

ACTIVATE

You start the program with **ACTIVATE** and the program will remain active until you choose to start another program. All settings are saved in the memory and they will not be lost even if the power is cut for longer than 48 hours, but you will need to reset the clock for everything to function normally again. For two seconds, you see a message confirming that the program has been activated. You can then see that the program is active because **HOTEL** is shown on the second line in display mode.

HIGH TEMP

The temperature can be set to between +5 °C and +45 °C. The thermostat reacts based on the temperature that is set in the manual program, where the factory setting is +25 °C. If the temperature is changed in the manual program, or the set point is changed in the **TEMP** menu, the thermostat will react based on the new temperature.

REMOTE CONTROL



The Hotel program is controlled by a remote control device, such as a card reader, connected to the designated terminal blocks. The thermostat switches from low to high temperature when the device's input circuit closes. When the input circuit opens, the thermostat returns to the "low" set point after the set time.

System setting menu SYSTEM

Under system settings, you will find settings for, for example, language and date, as well as resetting functions for the time counter and for complete resetting to factory settings. The system settings are under **SYSTEM** in the **MAIN MENU**.

Language LANGUAGE

You can choose between several languages; the factory setting is English.



Set the required language by scrolling through them using the  or  button and confirm with .

You can also use the shortcuts in the display mode (press  for three seconds). Then you go directly to the language menu. A practical function if you, by mistake, set the wrong language and then have difficulty finding the language menu again.



Date and time DATE/TIME

A set time and date can be changed if needed, for example, if the electrical supply to the thermostat was disrupted for a period of more than fifty hours. The setting function then comes up automatically.

You will find date and time setting in the **MAIN MENU** under **SYSTEM** and **DATE/TIME**. Change the value that blinks with either  or  and confirm with .



Summer and winter time S/W TIME

The thermostat calendar and clock are automatically set to summer and winter time but the function can, if it is not required, be switched off.

Summer and winter settings are in the **MAIN MENU** under **SYSTEM**; select **S/W TIME**. Switch off the function under **ON/OFF** in the menu and select **OFF**, a message is shown for a short time confirming that the function is switched off. Activate the function in the opposite way by selecting **ON**.

Sensor settings SENSOR

The thermostat can regulate temperature in three ways to accommodate both comfort temperature and possible temperature requirement for floor material.

The sensor settings are in the **SYSTEM** menu under **SENSOR**, and there select the sensor you want to use by browsing with  or  and confirm with .

Adaptive function ADAPTIVE

The thermostat has a function that calculates when heating should be started to provide the required temperature at the right time. The function is activated on delivery, but can be switched off as required.

You will find the settings for adaptive function in the **MAIN MENU** under **SYSTEM**, and there you select **ADAPTIVE**. Switch off the function under **ON/OFF** in the menu and select **OFF**, a message is shown for a short time confirming that the function is switched off. Activate the function in the opposite way by selecting **ON**.

Ventilation mode VENT

If the room temperature sinks by more than 3 °C in a minute, for example, when airing, ventilation mode is activated. The thermostat then deactivates heating for 15 minutes, after which it returns to the same setting; ventilation mode shows in the display when it is activated. The function is activated on delivery, but can be switched off as required.

You will find the settings for adaptive function in the **MAIN MENU** under **SYSTEM**, and there you select **ADAPTIVE**. Switch off the function under **ON/OFF** in the menu and select **OFF**, a message is shown for a short time confirming that the function is switched off. Activate the function in the opposite way by selecting **ON**.

FLOOR THERMOSTAT

The most common installation that suits most rooms and needs. A sensor placed in the floor measures the temperature and regulates the heating.

Note that the sensor measures the temperature below the surface; if the



thermostat is set as a floor thermostat, this is the temperature that you set in the **TEMP** menu and not the temperature in the room or on the surface of the floor.

ROOM THERMOSTAT

If the room is very large or has large areas of glass, it can sometimes be better to regulate the heating via a room sensor. A complementary sensor (E 85 816 22) is then required. When the thermostat is set as a room thermostat, it is the room temperature that is set in the **TEMP** menu.

ROOM THERMOSTAT WITH OVER HEATING PROTECTION

If you have a wood or laminate floor, you must use this installation to safeguard the floor material against over heating and damage. The preset temperature limitation setting is +35 °C. Read more about over heating protection in the section *Temperature menu*. A complementary sensor (E 85 816 22) is then required.



Reset RESET

There are three choices under the reset menu: **CONN TIME**, **OP MODE** and **FAC SET**. You will find the **RESET** menu under **SYSTEM** in the **MAIN MENU**.

Reset connection time CONN TIME



The connection time is shown in hours; as with a vehicle trip meter, it shows the number of hours an installation has been connected for since it was last reset. This is beneficial if you want to calculate the energy consumption for a certain period. The thermostat also has a counter that cannot be reset, which shows the total hours the installation has been connected for.

To see the total and momentary connection times, press when the thermostat is in display mode.

The reset function is in the **SYSTEM** menu under **RESET**; from here, select **CONN TIME**. This is preset to **NO** and is changed to **YES** by pressing  and confirming with .

Reset the operation mode settings OP MODE



You can reset the settings in **OP MODE HEATING**. All programs are reset and the temperature and sensor settings return to the output values. Resetting does not affect the choice of **OP MODE**, **LANGUAGE** or setting for **DATE/TIME**.

The reset function is in the **SYSTEM** menu under **RESET**, and there select **CONN TIME**. This is preset to **NO** and is changed to **YES** by pressing  and confirming with .

Reset factory settings FAC SET

The thermostat can be entirely reset to factory settings. All programmed data is deleted and the start up menu is opened. If you choose to reset the thermostat, it is important to know the operation mode it uses and the configuration of the sensors.

The only way to change operation mode is to reset to the factory settings.

The reset function is in the **SYSTEM MENU** under **RESET**; from here select **FACTORY SETTINGS**. This is preset to **NO** and is changed to **YES** by pressing  and confirming with .



Operation mode Cooling

Operation mode Cooling is used in home, office, storeroom environments and such like. In this operation mode, the thermostat works as a room thermostat for regulating air conditioning or other cooling within a temperature range of +5 °C to +45 °C. Energy saving programs are primarily adapted for home and office environments but can also be used for cooling, for example, storerooms.

Main menu MAIN MENU

MAIN MENU contains three submenus: TEMPERATURE, PROGRAM, SYSTEM and EXIT, which returns you to display mode.

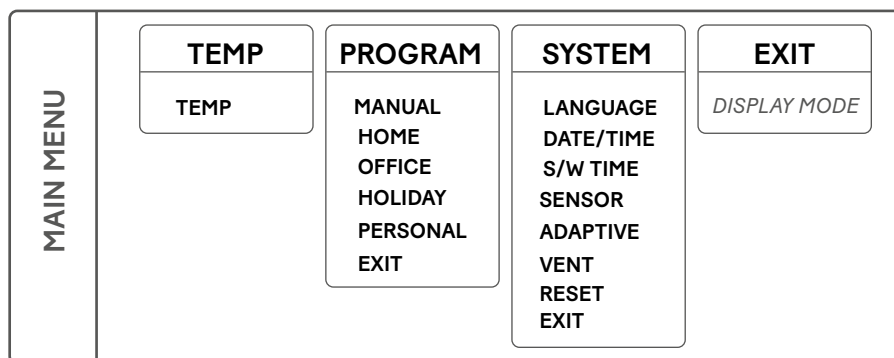

Temperature menu TEMP

The temperature menu contains the functions that in some way concern direct temperature control; this is where the set point is set. The temperature menu is reached via **TEMP** in the **MAIN MENU**.

Set point TEMP

The set point setting is under **TEMP** in the temperature menu. Set the required temperature by pressing \blacktriangledown or \blacktriangle and confirm by pressing \bullet . The set point can be set to an accuracy of 0.5 degrees within the range +5 °C to +45 °C; it is preset to +22 °C.

Program menu PROGRAM

A smart way of saving energy is to adapt the air conditioning to the needs throughout the day and, for example, lower the temperature when there is nobody there. There are four different ways of raising the temperature: two preset programs for home or office environments, one program for personal settings and a holiday program.

There is no need to consider the cooling time when programming since the thermostat has an adaptive function that applies this automatically.



The programs are in the **MAIN MENU** under **PROGRAM**. To change program, browse using \blacktriangledown or \blacktriangle and select using \bullet . The manual program is the factory setting, i.e. you set the required temperature (set point) and the thermostat maintains that temperature.

Program for home environment HOME

The temperature is raised by 5 °C at the following times:

Monday–Friday 08:30–15:00 and every day between 23:00–05:00.

The home environment program is under **PROGRAM** in the **MAIN MENU**. Select **HOME** using \bullet and a message is shown for two seconds to confirm that the program has been activated. You can then see in display mode that the program is active when **HOME** is shown on the second row.

The temperature can be set between +5 °C and +45 °C. The thermostat works from the temperature that is set in the manual program where the factory setting is +22 °C. If you change the temperature in the manual program, or set point in the **TEMP** menu, the thermostat works from the new temperature, and lowers the temperature by +5 °C from the new temperature.

Program for office environment OFFICE

The temperature is raised automatically by 5 °C apart from at the following times:

Monday–Friday 06:00–18:00.

The office environment program is under **PROGRAM** in the **MAIN MENU**. Select **OFFICE** using \bullet and a message is shown for two seconds to confirm that the program has been activated. You can then see in display mode that the program is active when **OFFICE** is shown on the second row.

The temperature can be set between +5 °C and +45 °C. The thermostat works from the temperature that is set in the manual program where the factory setting is +22 °C. If you change the temperature in the manual program, or set point in the **TEMP** menu, the thermostat works from the new temperature, and lowers the temperature by +5 °C from the new temperature.

Holiday program HOLIDAY

This program is intended for protection against over heating of, for example, electronic equipment in premises that are empty or unused for long periods, such as holiday homes and storerooms, or longer periods of absence from the normally used accommodation. The holiday program can be controlled via a remote control unit. There are three menu alternatives to choose between under **HOLIDAY: ACTIVATE, CHANGE and RESET**.

HOLIDAY is under **PROGRAM** in the **MAIN MENU**. The temperature can be set between +20 °C and +40 °C; the factory setting is +27 °C.



ACTIVATE

The program is started with **ACTIVATE**, and from there you can choose to use **TIMER SETTING**. If you want to start the program without the timer function, select **NO** and the program will then be active until another program is started. If you select **YES**, the program will remain active for the selected time and will then return to the previously used program.

The first time the program is used, the time and temperature must be set under **CHANGE**. All the settings are saved in the memory and are not lost even if a power cut occurs, but, in this case, the clock must be reset to obtain normal functionality again.

CHANGE

To make changes to the settings, select **CHANGE**; **TEMP** is used to set the temperature you want the thermostat to maintain when the program is activated, **TIMER** is used to reset the current start and stop times; **REMOTE** is used to activate remote control if applicable.

RESET

There is also a reset function, which resets the program to the factory setting, +27 °C, and deletes all the time settings.

REMOTE CONTROL

The holiday program can be controlled via a remote control unit. The unit is connected to the applicable terminal block; see the wiring diagram. The holiday program is activated when the remote control input is closed, and is deactivated when it is opened again. The thermostat then returns to its previous setting.

Personal program PERSONAL

Manual setting of the program allows optimisation of energy consumption to suit just your needs by making settings for four events each day: **WAKE**, **AWAY**, **HOME** and **NIGHT**. There are three menu alternatives to choose between: **ACTIVATE**, **CHANGE** and **RESET**.

The personal program **PERSONAL** is under **PROGRAM** in the **MAIN MENU**. The temperature can be set between +5 °C and +45 °C; the factory setting is +22 °C.

ACTIVATE

The program is started with **ACTIVATE** and it remains active until another program is started. The first time the program is used, the time and temperature must be set under **CHANGE**. All the settings are saved in the memory and are not lost even if a power cut occurs for a period longer than two days, but, in this case, the clock must be reset to obtain normal functionality again.

CHANGE



To set your personal program, go in under **CHANGE**. There are different ways of setting the various events; you can choose to program day by day, weekend (Saturday and Sunday) or the whole week. It is normally easiest to set the whole week first and then adjust this for the days requiring a different setting.

When you have decided on the day(s) the event shall be set for, set the time of day they shall occur at and the required room temperature at that time.

Start by setting the time, which is blinking. Browse with the \blacktriangledown or the \blacktriangle button to the time you want the event **WAKE** to occur. First set hours, confirm with \bullet , then minutes, confirm with \bullet . Browse to the required temperature for **WAKE**. Confirm with \bullet and **AWAY** then shows. Repeat the steps above to set the time and temperature, and **HOME** then shows. Repeat the steps above to set the time and temperature, and **NIGHT** then shows. Repeat the steps above to set the time and temperature.

RESET

There is also a reset function, which resets the program to the factory setting, +22 °C, and deletes all the time settings.

System setting menu SYSTEM

Under system settings, you will find settings for, for example, language and date, as well as resetting functions for the time counter and for complete resetting to factory settings. The system settings are under **SYSTEM** in the **MAIN MENU**.

Language LANGUAGE

You can choose between several languages; the factory setting is English.

Set the required language by scrolling through them using the \blacktriangledown or \blacktriangle button and confirm with \bullet .

You can also use the shortcuts in the display mode (press \blacktriangle for three seconds). Then you go directly to the language menu. A practical function if you, by mistake, set the wrong language and then have difficulty finding the language menu again.

Date and time DATE/TIME

A set time and date can be changed if needed, for example, if the electrical supply to the thermostat was disrupted for a period of more than fifty hours. The setting function then comes up automatically.

You will find date and time setting in the **MAIN MENU** under **SYSTEM** and **DATE/TIME**. Change the value that blinks with either \blacktriangledown or \blacktriangle and confirm with \bullet .



Summer and winter time S/W TIME

The thermostat calendar and clock are automatically set to summer and winter time but the function can, if it is not required, be switched off.

Summer and winter settings are in the **MAIN MENU** under **SYSTEM**; select **S/W TIME**. Switch off the function under **ON/OFF** in the menu and select **OFF**, a message is shown for a short time confirming that the function is switched off. Activate the function in the opposite way by selecting **ON**.

Sensor settings SENSOR

The sensor settings are in the **SYSTEM** menu under **SENSOR**, and there select the sensor you want to use by browsing with \blacktriangledown or \blacktriangle and confirm with \bullet .

The thermostat works as a Room thermostat and measures the temperature using a room sensor. When the thermostat is used to regulate cooling, the room sensor can be installed either as **A** or **B**. It is only possible to use one sensor at a time, but if there are two sensors installed you can switch between **A** and **B**.

Adaptive function ADAPTIVE

The thermostat has a function that calculates when heating should be started to provide the required temperature at the right time. The function is activated on delivery, but can be switched off as required.

You will find the settings for adaptive function in the **MAIN MENU** under **SYSTEM**, and there you select **ADAPTIVE**. Switch off the function under **ON/OFF** in the menu and select **OFF**, a message is shown for a short time confirming that the function is switched off. Activate the function in the opposite way by selecting **ON**.

Ventilation mode VENT

If the room temperature increases by more than 3 °C in a minute, for example, when airing, ventilation mode is activated. The thermostat then deactivates heating for 15 minutes, after which it returns to the same setting; ventilation mode shows in the display when it is activated. The function is activated on delivery, but can be switched off as required.

You will find the settings for adaptive function in the **MAIN MENU** under **SYSTEM**, and there you select **ADAPTIVE**. Switch off the function under **ON/OFF** in the menu and select **OFF**, a message is shown for a short time confirming that the function is switched off. Activate the function in the opposite way by selecting **ON**.

Reset RESET



There are three choices under the reset menu: **CONN TIME**, **OP MODE** and **FAC SET**. You will find the **RESET** menu under **SYSTEM** in the **MAIN MENU**.



Reset connection time CONN TIME



The connection time is shown in hours; as with a vehicle trip meter, it shows the number of hours an installation has been connected for since it was last reset. This is beneficial if you want to calculate the energy consumption for a certain period. The thermostat also has a counter that cannot be reset, which shows the total hours the installation has been connected for.

To see the total and momentary connection times, press when the thermostat is in display mode.

The reset function is in the **SYSTEM** menu under **RESET**; from here, select **CONN TIME**. This is preset to **NO** and is changed to **YES** by pressing  and confirming with .

Reset the operation mode settings OP MODE



The settings can be reset in **OP MODE COOLING**. All programs are reset and the temperature and sensor settings return to the output values. Resetting does not affect the choice of **OP MODE**, **LANGUAGE** or setting for **DATE/TIME**.

The reset function is in the **SYSTEM** menu under **RESET**, and there select **CONN TIME**. This is preset to **NO** and is changed to **YES** by pressing  and confirming with .

Reset factory settings FAC SET

The thermostat can be entirely reset to factory settings. All programmed data is deleted and the start up menu is opened. If you choose to reset the thermostat, it is important to know the operation mode it uses and the configuration of the sensors.

The only way to change operation mode is to reset to the factory settings.

The reset function is in the **SYSTEM MENU** under **RESET**; from here select **FACTORY SETTINGS**. This is preset to **NO** and is changed to **YES** by pressing  and confirming with .







Operation mode Industry

Operation mode Industry is used to regulate the temperature of industrial processes, high temperatures or for the frost protection of sensitive installations. Temperatures within the ranges -15 °C to +75 °C and 0 °C to +150 °C can be regulated in this mode or the range can be limited to between -10 °C and +15 °C for frost protection purposes. It is also possible to adjust temperature hysteresis and set upper and lower temperature alarms.

Main menu MAIN MENU

The **MAIN MENU** contains three submenus: **TEMPERATURE**, **PROGRAM** and **SYSTEM**.

From display mode, go to the **MAIN MENU** by pressing  once. Use the  or  buttons to move between the menus and confirm using .

If you do not press a button for 30 seconds, the thermostat returns to display mode; you can also return to display mode by selecting **EXIT**.

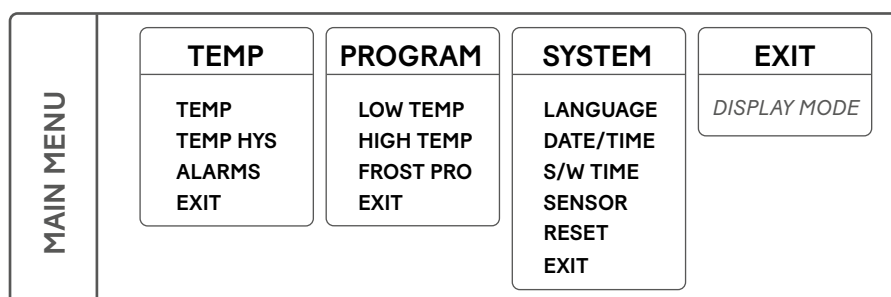



Temperature menu TEMP

The temperature menu contains the functions that in some way concern direct temperature regulation. This is where the set point, hysteresis and temperature alarm are set. The temperature menu is reached via **TEMP** in the **MAIN MENU**.

Set point TEMP

The set point can be set to an accuracy of 0.5 degrees and is set in two overlapping ranges. The lower temperature range is from -15 °C to +75 °C and the upper from 0 °C to +150 °C. The factory setting is +40 °C or +100 °C depending on the temperature range selected.

The set point setting is under **TEMP** in the **TEMP** menu. Set the required temperature by pressing  or  and then confirm with .

* Read more about temperature hysteresis and how to set it on page 23.





Temperature hysteresis TEMP HYS

The thermostat can be prevented from switching on and off the effect too often by increasing the temperature hysteresis.

The hysteresis is the range the current value is permitted to deviate from the set point without the thermostat switching on or off the effect. A set hysteresis value of 0.3 °C and a set point of +40.0 °C means that the temperature (current value) can vary between +39.7 °C and +40.3 °C.

The hysteresis can be increased if the system does not operate smoothly, i.e. the thermostat continually switches on and off the effect. Excessive switching increases wear on the relay and reduces the service life of the thermostat considerably.

The hysteresis setting is in the **TEMP** menu under **TEMP HYS**; increase and decrease the value using  or  and then confirm with . The factory setting is +0.8 °C and is set in steps of 0.5 °C. The max value is +10.3 °C and the min is +0.3 °C.

Temperature alarm ALARM

EB Therm 800 has both an upper and a lower temperature alarm. If the temperature exceeds or falls below the set temperature, the installation is switched off, the alarm circuit is opened and the display shows an alarm message at the same time as the background lightning blinks. The menu settings are accessed as usual by pressing .

The temperature alarm is not activated in the factory settings. The function is in the **ALARM** menu under **TEMP** in the **MAIN MENU**. Activate the temperature alarm in the **ALARM** menu under **ON/OFF**, and there select **ON** to activate it. To deactivate it, select **OFF**. The message that the alarm is on or off is shown for two seconds.

SUB TEMPERATURE ALARM SUB TEMP

If the temperature (current value) falls below the set alarm temperature, the installation is switched off, the alarm circuit is opened and the display shows **SUB TEMP ALARM** at the same time as the background lighting blinks. The menu settings are accessed as usual by pressing . When the temperature rises above the set alarm temperature again, or if the alarm temperature is set to below the current value, the alarm circuit closes and the installation returns to normal operation.

The factory set sub temperature limit is +40 °C and the high temperature limit is +100 °C.

EXCESS TEMPERATURE ALARM EXCESS TEMP



If the temperature (current value) exceeds the set alarm temperature, the installation is switched off, the alarm circuit is opened and the display shows **EXCESS TEMP ALARM** at the same time as the background lighting blinks. When the temperature falls below the set alarm temperature again, or if the alarm temperature rises above the current value, the alarm circuit closes and the installation returns to normal operation.

The factory set sub temperature limit is +60 °C and the excess temperature limit is +150 °C.



Program menu PROGRAM

To be able to measure the temperature as accurately as possible, there are two temperature ranges, one from -15 °C to +75 °C and one from 0 °C to +150 °C. There is also a frost protection program to enable sensitive installations to be safeguarded against frost in a simple manner.

The low temperature and frost programs are in the **MAIN MENU** under **PROGRAM**. To change program, browse using  or  and select with . The low temperature program is set at the factory.

The high temperature sensor (see below) must be connected and activated to activate the high temperature program. If the high temperature sensor is not activated in the start menu, it can be activated from the **MAIN MENU** under **SYSTEM** and **SENSOR**; here select **B: HIGH TEMP**.



IMPORTANT – The sensor that is provided with EB Therm 800 is intended for the low temperature and frost protection program, and must not be used with the high temperature program. The sensor for the high temperature program is not included in the package, but must be ordered separately; it has part number E 85 816 73. Only one high temperature sensor can be connected. It must always be connected as B, terminal block 7 and 8.

Low temperature program LOW TEMP

This program limits the temperature range to between -15 °C and +75 °C. This program is provided for two reasons, partly to minimise the risk of the wrong sensor being used, which would damage the installation, and because the different temperature ranges demand sensors with different characteristics.

Select the lower temperature range in the **MAIN MENU** under **PROGRAM** and **LOW TEMP**. This program is preselected but can be changed to the frost protection or high temperature program at any time.

Frost protection program FROST PRO

The program is intended for the frost protection of installations or pipes and limits the settable temperature range to between -10 °C and +15 °C. The values can be set with an accuracy of 0.5 degrees and the factory setting is +5 °C.

Select the program in the **MAIN MENU** under **PROGRAM** and **FROST PRO**. It is preselected but can be changed to the frost protection or high temperature program at any time.

High temperature program HIGH TEMP

This program limits the temperature range to between 0 °C and +150 °C. This program is provided for two reasons, partly to minimise the risk of the wrong sensor being used, which would damage the installation, and because the different temperature ranges demand sensors with different characteristics.







System setting menu SYSTEM

Under system settings, you will find settings for, for example, language and date, as well as resetting functions for the time counter and for complete resetting to factory settings. The system settings are under **SYSTEM** in the **MAIN MENU**.

Language LANGUAGE

You can choose between several languages; the factory setting is English.

Set the required language by scrolling through them using the  or  button and confirm with .

You can also use the shortcut in the display mode (press  for three seconds). Then go directly to the language menu. A practical function if you, by mistake, set the wrong language and then have difficulty finding the language menu again.

Date and time DATE/TIME

A set time and date can be changed if needed, for example, if the electrical supply to the thermostat was disrupted for a period of more than fifty hours. The setting function then comes up automatically.

The date and time setting is in the **MAIN MENU** under **SYSTEM** and **DATE/TIME**. Change the value that blinks with either  or  and confirm with .

Summer and winter time S/W TIME

The thermostat calendar and clock are automatically set to summer and winter time but the function can, if it is not required, be switched off.

Summer and winter settings are in the **MAIN MENU** under **SYSTEM**; select **S/W TIME**. Switch off the function under **ON/OFF** in the menu and select **OFF**, a message is shown for a short time confirming that the function is switched off. Activate the function in the opposite way by selecting **ON**.

Sensor settings SENSOR

The thermostat uses external sensors that can be installed either as **A** or **B**. It is only possible to use one sensor at a time, but if there are two sensors installed, you can switch between **A** and **B**.

The sensor settings are in the **SYSTEM MENU** under **SENSOR**, and there select the sensor you want to use by browsing with  or  and confirm with .





Reset RESET

There are three choices under the reset menu: **CONN TIME**, **OP MODE** and **FAC SET**. The **RESET** menu is under **SYSTEM** in the **MAIN MENU**.

Reset connection time CONN TIME



The connection time is shown in hours; as with a vehicle trip meter, it shows the number of hours an installation has been connected for since it was last reset. This is beneficial if you want to calculate the energy consumption for a certain period. The thermostat also has a counter that cannot be reset, which shows the total hours the installation has been connected for.

To see the total and momentary connection times, press when the thermostat is in display mode.

The reset function is in the **SYSTEM** menu under **RESET**; from here, select **CONN TIME**. This is preset to **NO** and is changed to **YES** by pressing  and confirming with .

Reset the operation mode settings OP MODE



Settings can be reset in **OP MODE INDUSTRY**. All programs are reset and the temperature and sensor settings return to the output values. Resetting does not affect the choice of **OP MODE**, **LANGUAGE** or setting for **DATE/TIME**.

The reset function is in the **SYSTEM** menu under **RESET**, and there select **CONN TIME**. This is preset to **NO** and is changed to **YES** by pressing  and confirming with .

Reset factory settings FAC SET

The thermostat can be entirely reset to factory settings. All programmed data is deleted and the start up menu is opened. If you choose to reset the thermostat, it is important to know the operation mode it uses and the configuration of the sensors.

The only way to change operation mode is to reset to the factory settings.

The reset function is in the **SYSTEM MENU** under **RESET**; from here select **FACTORY SETTINGS**. This is preset to **NO** and is changed to **YES** by pressing  and confirming with .



Operation mode Max/Min





The Max/Min operating position is mainly used to keep roof and ground surfaces free of snow and ice. The temperature range is adjustable between $-20\text{ }^{\circ}\text{C}$ and $+10\text{ }^{\circ}\text{C}$. For the best results and the best energy saving, combined temperature and humidity control should be used in the Max-/Min position, with associated Roof Sensor (E 89 350 75) or Ground Sensor (E 85 801 01).



To use the thermostat in Max/Min mode for roof installation, you will probably need to complement with IP54 outdoor encapsulation (E 85 816 22) and Roof sensor (E 89 350 75). The encapsulation should be placed where it is permanently shady, e.g. on the north side or shady side. Ensure that it is not affected by heat emittance from the building or a heating cable.

Main menu MAIN MENU

The MAIN MENU contains three submenus: TEMPERATURE, PROGRAM and SYSTEM.

From display mode, go to the MAIN MENU by pressing  once. Use the  or  button to move between the menus, and confirm using .

If you do not press a button for 30 seconds, the thermostat returns to display mode; you can also return to display mode by selecting EXIT.

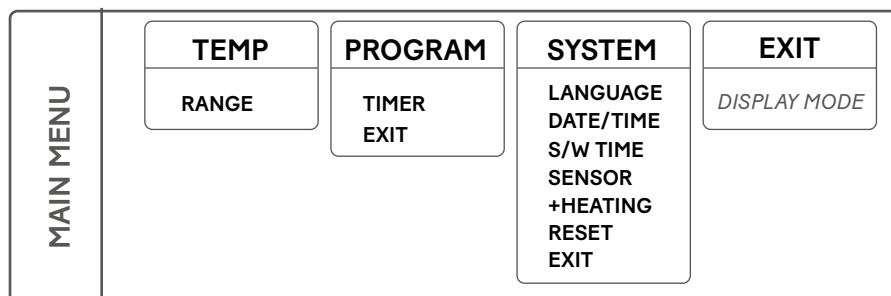

Temperature menu TEMP

The temperature menu contains the functions that in some way concern direct temperature regulation. This is where the temperature range and temperature hysteresis are set. The temperature menu is reached via TEMP in the MAIN MENU.

Temperature range RANGE

You find the temperature range settings under TEMP in the temperature menu. This function is used to set the temperatures which the thermostat is active between. The max value is the upper temperature in the range and min value is the lower temperature.

If the max value is set to $+2\text{ }^{\circ}\text{C}$ and the min value to $-10\text{ }^{\circ}\text{C}$, the thermostat is activated when the temperature falls to $+2\text{ }^{\circ}\text{C}$; if it falls further, to below $-10\text{ }^{\circ}\text{C}$, the thermostat is deactivated again until the temperature rises to within the set temperature range.



Set the required max temperature by pressing \blacktriangledown or \blacktriangle and confirm with \bullet , then set the required min temperature in the same way. The values can be set with an accuracy of 0.5 degrees, and the factory settings are max +2 °C and min -10 °C. Both max and min temperatures can be set between +10 °C and -20 °C.

Two sensors can be installed on the thermostat. If two sensors are used simultaneously, the temperature must be within the set range for *both* sensors for the thermostat to be activated.

Program menu PROGRAM

In Operation mode **MAX/MIN**, there is a timer program that makes it possible to customise snow melting further in order to save energy.

You will find **TIMER** under **PROGRAM** in **MAIN MENU**.

Timer TIMER

A smart way of saving energy is to adapt snow melting to your needs over a 24-hour period. Up to four on and off switchings can be programmed in the timer program, i.e. it will only be active during certain periods of the day or during certain days. There are three menu alternatives to choose between: **ACTIVATE**, **EVENTS** and **RESET**.

The **TIMER** function is under **PROGRAM** in the **MAIN MENU**. To start the timer program, select **TIMER** and then **ON**; to switch off the timer, select **OFF**. When **OFF** or **ON** have been selected, a message is shown for two seconds confirming that the function has been activated or deactivated. In the factory settings, the temperature alarm is deactivated.

ACTIVATE

The program is started with the activate function, and it remains active until another program is started. The first time the program is run, the times must be set under **EVENTS**. All the settings are saved in the memory and are not lost even if a power cut occurs, but, in this case, the clock must be reset to obtain normal functionality again.

EVENTS

To set the **TIMER** program, go to **CHANGE** or **EVENTS**. There are different ways of setting the various program events: you can choose to program day by day, weekend (Saturday and Sunday) or the whole week. It is normally easiest to set the whole week first and then adjust this for the days requiring a different setting.

When you have selected the day(s), set the number of events (max 4) and the times during the day they shall occur. Browse with the \blacktriangledown or \blacktriangle button to change the number events, and confirm using \bullet .

To set an event, start by setting the time, which is blinking. Browse with the \blacktriangledown or the \blacktriangle button to the time you want the event **ON** to occur. First set hours, confirm with \bullet , then minutes, confirm with \bullet . Repeat the steps above to set **OFF**.



Example: You want snow melting to be deactivated between 22:00 and 04:00 and between 11:00 and 15:00 every day, i.e. the installation shall be active between 04:00–11:00 and 15:00–22:00. First select **WEEK** and then **2 EVENTS**. The first event is **ON** at 04:00 and **OFF** at 11:00. The second event is **ON** at 15:00 and **OFF** at 22:00.

RESET

There is also a reset function, which resets the program to the factory setting, Max +2 °C and Min -10 °C, and deletes all the set events.

System setting menu SYSTEM

Under system settings, you will find settings for, for example, language and date, as well as resetting functions for the time counter and for complete resetting to factory settings. The system settings are under **SYSTEM** in the **MAIN MENU**.

Language LANGUAGE

You can choose between several languages; the factory setting is English.

Set the required language by scrolling through them using the \blacktriangledown or \blacktriangle button and confirm with \bullet .

You can also use the shortcut in the display mode (press \blacktriangle for three seconds). Then go directly to the language menu. A practical function if you, by mistake, set the wrong language and then have difficulty finding the language menu again.

Date and time DATE/TIME

A set time and date can be changed if needed, for example, if the electrical supply to the thermostat was disrupted for a period of more than fifty hours. The setting function then comes up automatically.

The date and time setting is in the **MAIN MENU** under **SYSTEM** and **DATE/TIME**. Change the value that blinks with either \blacktriangledown or \blacktriangle and confirm with \bullet .

Summer and winter time S/W TIME

The thermostat calendar and clock are automatically set to summer and winter time but the function can, if it is not required, be switched off.

Summer and winter settings are in the **MAIN MENU** under **SYSTEM**; select **S/W TIME**. Switch off the function under **ON/OFF** in the menu and select **OFF**, a message is shown for a short time confirming that the function is switched off. Activate the function in the opposite way by selecting **ON**.

Sensor settings SENSOR

The sensor settings are in the **SYSTEM MENU** under **SENSOR**, and there select the sensor you want to use by browsing with \blacktriangledown or \blacktriangle and confirm with \bullet .



Temperature, A and B

The thermostat uses external sensors that can be installed as A or B. If there are two sensors installed, it is possible to switch between A, B or A & B.

Moisture sensor, C

The thermostat uses moisture sensor C together with temperature sensor A.

Delay +HEATING

The delay can be set to ensure that the entire installation is free of snow and ice before the thermostat is switched off. When the moisture sensor no longer detects moisture, the thermostat will remain active for the set time, before it switches off. The need for delay varies depending on the installation and the location of the sensor.

A delay of up to four hours can be set, in intervals of 30 minutes. The factory setting is zero.



Reset RESET

There are three choices under the reset menu: **CONN TIME**, **OP MODE** and **FAC SET**. The **RESET** menu is under **SYSTEM** in the **MAIN MENU**.

Reset connection time CONN TIME



The connection time is shown in hours; as with a vehicle trip meter, it shows the number of hours an installation has been connected for since it was last reset. This is beneficial if you want to calculate the energy consumption for a certain period. The thermostat also has a counter that cannot be reset, which shows the total hours the installation has been connected for.

To see the total and momentary connection times, press  when the thermostat is in display mode.

The reset function is in the **SYSTEM** menu under **RESET**; from here, select **CONN TIME**. This is preset to **NO** and is changed to **YES** by pressing  and confirming with .

Reset the operation mode settings OP MODE



Settings can be reset in **OP MODE MAX/MIN**. All programs are reset and the temperature and sensor settings return to the output values. Resetting does not affect the choice of **OP MODE**, **LANGUAGE** or setting for **DATE/TIME**.

The reset function is in the **SYSTEM** menu under **RESET**, and there select **CONN TIME**. This is preset to **NO** and is changed to **YES** by pressing  and confirming with .

Reset factory settings FAC SET

The thermostat can be entirely reset to factory settings. All programmed data is deleted and the start up menu is opened. If you choose to reset the thermostat, it is important to know the operation mode it uses and the configuration of the sensors.

The only way to change operation mode is to reset to the factory settings.

The reset function is in the **SYSTEM MENU** under **RESET**; from here select **FAC SET**. This is preset to **NO** and is changed to **YES** by pressing  and confirming with .

Fault tracing

Message	Cause
<i>DISRUPTION ON SENSOR A</i>	The sensor installed on terminal blocks 5 and 6 is not correctly connected or is damaged.
<i>DISRUPTION ON SENSOR B</i>	The sensor installed on terminal blocks 7 and 8 is not correctly connected or is damaged.
<i>SHORT CIRCUIT ON SENSOR A</i>	The sensor installed on terminal blocks 5 and 6 is not correctly connected or is damaged.
<i>SHORT CIRCUIT ON SENSOR B</i>	The sensor installed on terminal blocks 7 and 8 is not correctly connected or is damaged.
<i>DATE/TIME</i> <i>[setting blinks]</i>	<p>If the thermostat has been without electrical supply for 50 hours, the reserve supply has run out. This means that the processor that runs the clock has stopped and that the date and time must be reinstalled. All other settings are still saved in the memory.</p> <p>Set the date and time, and the thermostat will operate normally again.</p>
<i>SET: LANGUAGE – DATE/ TIME – OPERATION MODE – SENSOR</i>	If you have forgotten to make a setting in the start up menu, you must go back in the menu and make the setting before you can exit start up mode.
<i>EXCESS TEMP ALARM</i> <i>[blinking display]</i>	Means that the current value has exceeded the set alarm temperature. The thermostat switches of the load but otherwise works as usual until the current value sinks below the set alarm temperature or the alarm temperature is set above the current value.
<i>SUB TEMP ALARM</i> <i>[blinking display]</i>	Means that the current value has fallen below the set alarm temperature. The thermostat breaks the load but otherwise works as usual until the current value rises above the set alarm temperature or the alarm temperature is set below the current value.
<i>OVER HEATING PROTECTION ACTIVE</i>	If the text is shown in the display mode, this means that the current value in the floor has exceeded the set temperature for the over heating protection. The thermostat switches of the load but otherwise works as usual until the current value sinks below the set alarm temperature or the alarm temperature is set above the current value.

Technical data

Voltage	230 VAC +/- 10 % ~50 Hz
Break-off capacity	3680 W/16 A/230 VAC
Power consumption	2.5 W
Application range	-20 °C to +150 °C divided into two ranges
Low temperature range	-20 °C to +75 °C – Sensor type NTC
High temperature range	0 °C to +150 °C – Sensor type PTC
Roof sensor, moisture	24 VDC, NO
Connection cable	max 2.5mm ²
Loading	cos φ = 1
Connection difference	Adjustable +/- 0.3 to 10.3 °C
Encapsulation class	IP20
Reserve power	50 hours
Max length, sensor cable	50 m, 2x1.5 mm ²
Alarm relay	2 A/120 VAC Normal connection
Installation	Standard DIN-rail EN 50022-35
Ambient temperature	-20 °C to +45 °C

Test value for NTC sensor

-10 °C	42.5 kΩ
0 °C	27.3 kΩ
+10 °C	18.0 kΩ
+20 °C	12.1 kΩ
+25 °C	10.0 kΩ

Test value for PTC sensor

+70 °C	1392 Ω
+90 °C	1591 Ω
+110 °C	1805 Ω
+130 °C	2023 Ω
+150 °C	2211 Ω

Certification: EMC/2500 VAC RoHS WEEE CB



Unit dimensions drawing

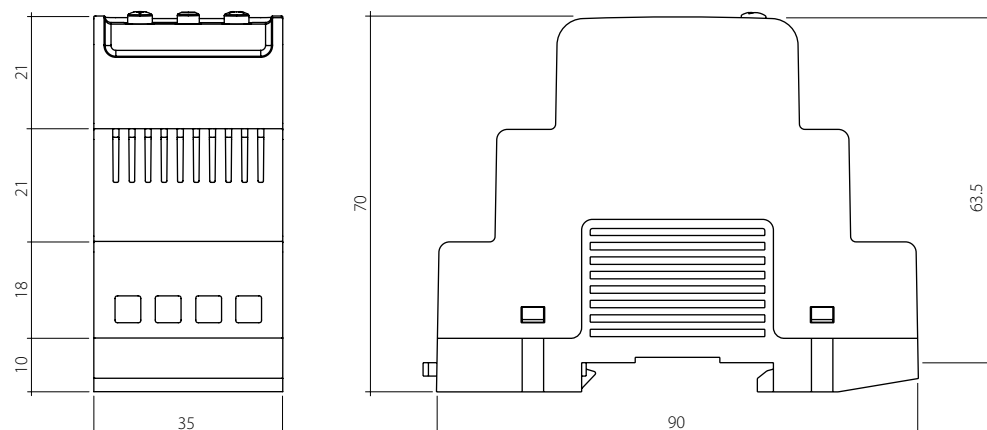

EBECO AB

Lärjeågatan 11
415 02 Göteborg
SWEDEN

+46 31 707 75 50
info@ebeco.se

ebeco.se